

KORLOY Indexable new generation drill

KING DRILL



Optimized design of inserts for maximum drilling efficiency

- Excellent cutting performance and chip control due to the optimized geometry and chip breaker of both inserts, central & peripheral
- 2 different inserts, optimized for the central and peripheral insert locations in order to maximize cutting tool life



KING DRILL

Optimized insert design for maximum drilling efficiency

KING DRILL

Code system of holder

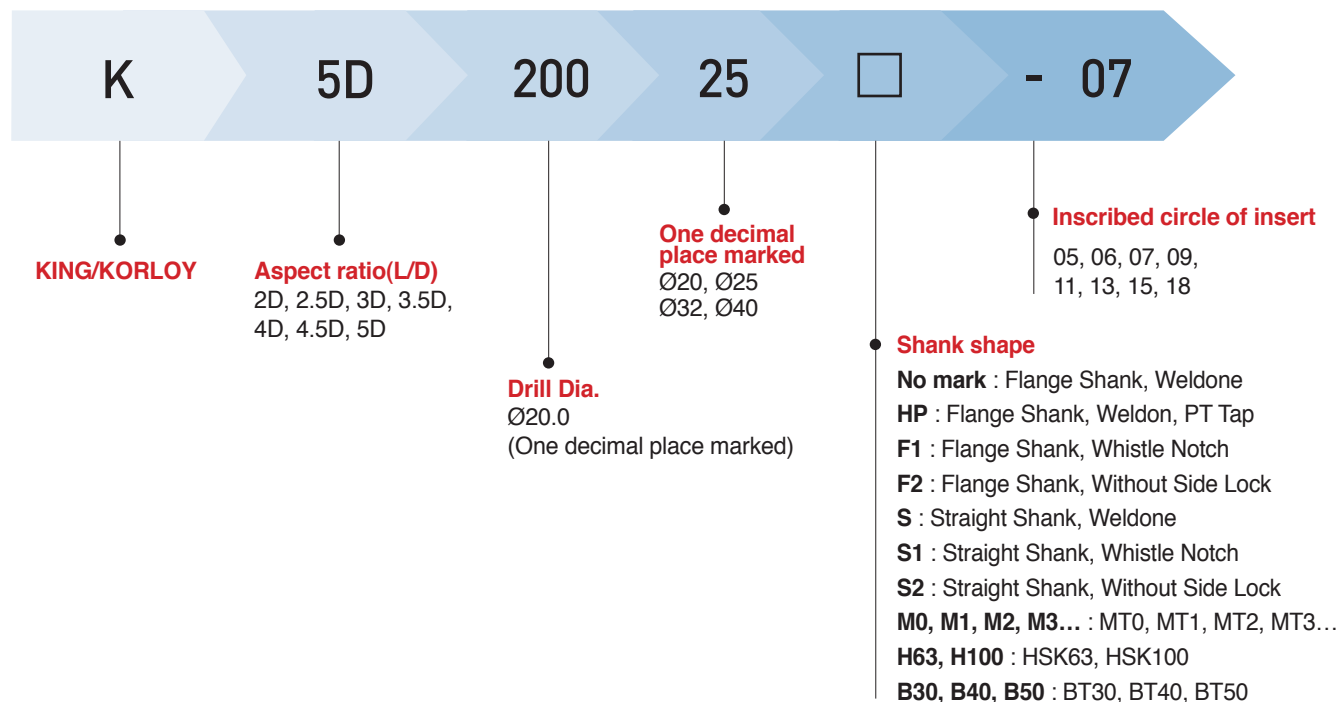

Features of insert

• **Optimized design of inserts for maximum drilling efficiency**

- Excellent cutting performance and chip control due to the optimized geometry and chip breaker of both inserts, central & peripheral
- Different inserts, optimized for the central and peripheral insert locations in order to maximize cutting tool life

Chip breaker	PD		LD	
Features	- Universal - At medium speed and medium feed		- Superior chip control for machining mild steel and stainless steel - Light cutting(at low ~ medium speed and low feed)	
Insert	Peripheral insert	Central insert	Peripheral insert	Central insert
Shape				
Grades for workpiece	PC3500 : P PC5300 : P, M, K, S PC6510 : K	PC5300 : P, M, K, S	PC5335 : P, M	PC5335 : P, M

Features of drill



- The center coolant hole system helps prevent wear on the chip pocket of the central insert and improves chip control.
- The optimized shape of the flute increases the rigidity of the drill body and improves chip evacuation.

Machining performance

• Tool life comparison

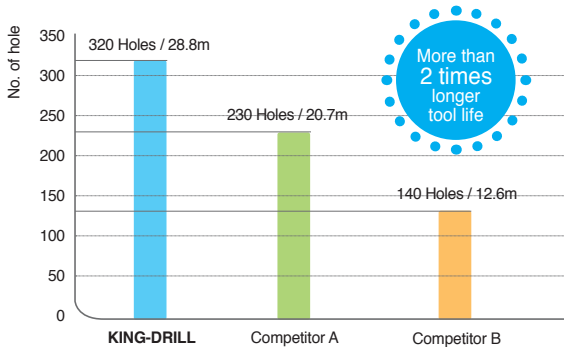

• KING DRILL has the best tool life.



- KING DRILL
320 Holes (28.8m)
Normal wear
- Competitor A
230 Holes (20.7m)
Chipping on cutting edge
- Competitor B
140 Holes (12.6m)
Wear and chipping on cutting edge

- **Workpiece** SCM440
- **Cutting condition** $vc(m/min)=150$, $fn(mm/rev)=0.1$
Depth of drilling : 80mm(pass through), wet
- **Tools**
Insert SPMT060205-PD(PC3500), XOMT060204-PD(PC5300)
Holder K5D18025-06

• Surface roughness

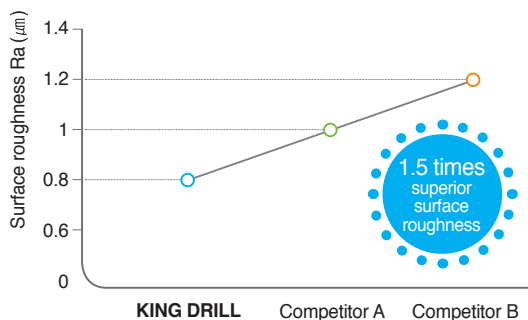

• Superior surface roughness of KING DRILL

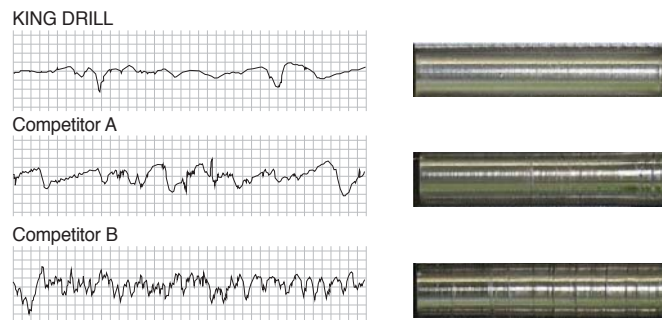

- **Workpiece** SCM440
- **Cutting condition** $vc(m/min)=150$, $fn(mm/rev)=0.08$, Depth of drilling : 60mm(pass through), wet
- **Tools**
Insert SPMT050204-PD(PC3500), XOMT050204-PD(PC5300)
Holder K5D14020-05



KING DRILL

Precision of machining

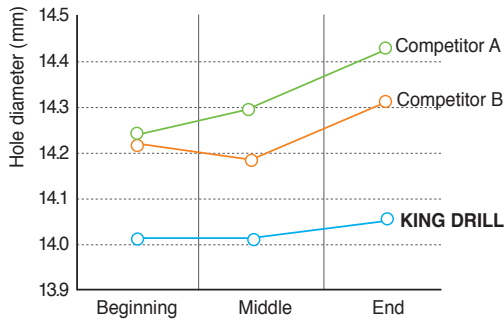

More than 2 times longer tool life

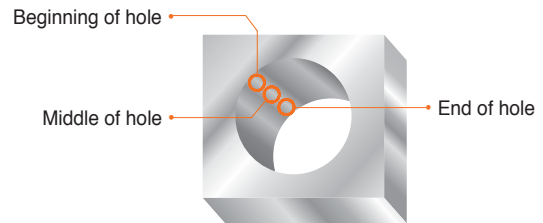

- **Workpiece** SCM440
- **Cutting condition** $vc(m/min)=150$, $fn(mm/rev)=0.08$
Depth of drilling 6m(pass through), wet
- **Tools** **Insert** SPMT050204-PD(PC3500), XOMT050204-PD(PC5300)
Holder K5D14020-05

- **KING DRILL**
Regular hole diameters at the beginning, middle and end of hole
- **Competitor A**
Hole diameter : beginning < middle < end
- **Competitor B**
Bigger hole diameter at the end of hole

• The diameters of beginning, middle, and end of hole are regular after drilling with KING DRILL.

Chip evacuation



- KING DRILL**
- Stable chip control

- Competitor A**
- Thin and long chips are coiled around the holder.

- Competitor B**
- Folded chips under certain cutting condition
 - Poor chip evacuation

- **Workpiece** SM45C
- **Cutting condition** $vc(m/min)=90\sim 180$, $fn(mm/rev)=0.06\sim 0.12$, $t(mm)=90$, Through coolant system, pass through
- **Tools** **Insert** SPMT07T208-PD(PC3500), XOMT07T205-PD(PC5300)
Holder K5D20025-07

Application examples

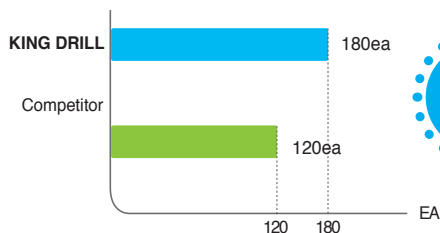

150% longer tool life

- Superior surface finish and chip evacuation
- KING DRILL : 180ea, Competitor's : 120ea
- 150% longer tool life

[workpiece]



- **Workpiece** Track link bush
- **Cutting condition** $vc(m/min)=120$, $fn(mm/rev)=0.1$
Through coolant system
- **Tools** **Insert** SPMT07T208-PD(PC3500), XOMT07T205-PD(PC5300)
Holder K5D20025-07
- **Machine** Drilling machine

• Example of longer tool life

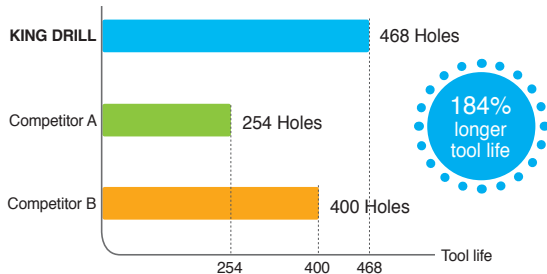

[workpiece]



- **Workpiece** Hydraulic oil pump(SCM440)
- **Cutting condition** $vc(m/min)=152$
 $fn(mm/rev)=0.13$
 $ap(mm)=59$ (not pass though)
Through coolant system
- **Tools** **Insert** SPMT090308-PD(PC3500)
XOMT090305-PD(PC5300)
Holder K3D25532-09
- **Machine** KV45

- Superior chip evacuation and surface finish
- 184% longer tool life comparing to competitor A
- 117% longer tool life comparing to competitor B

• Example of improved productivity

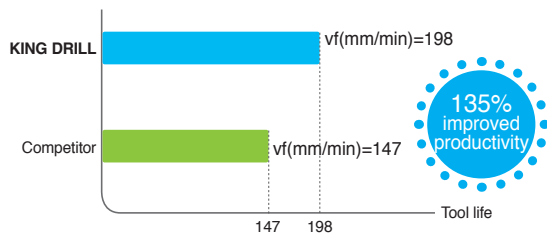

[workpiece]



- **Workpiece** Track link bush(SCM415H)
- **Cutting condition** **Competitor's** $vc(m/min)=125$ $fn(mm/rev)=0.1$
Korloy's $vc(m/min)=140$ $fn(mm/rev)=0.12$
- **Tools** **Insert** SPMT090308-PD(PC3500)
XOMT090305-PD(PC5300)
Holder K3D27025-09
- **Machine** MCT

- KING DRILL : 95 Holes, Competitor : 70 Holes, 135% longer tool life
- 135% improved productivity

• Example of improved productivity and tool life

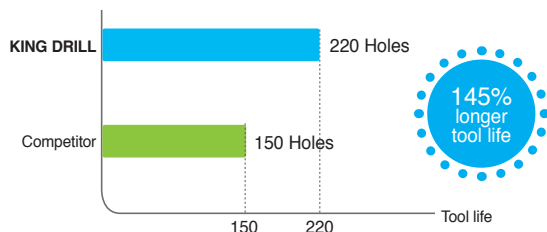

[workpiece]



Chips from KING DRILL



Chips from competitor's

- **Workpiece** Track link(15b36C12)
- **Cutting condition** **Competitor's** $vc(m/min)=47$, $fn(mm/rev)=0.1$, Through coolant system
Korloy's $vc(m/min)=110$, $fn(mm/rev)=0.1$, Through coolant system
- **Tools** **Insert** SPMT090308-PD(PC3500), XOMT090305-PD(PC5300)
Holder K3D27025-09
- **Machine** MCT

- KING DRILL has 145% longer tool life and 200% improved productivity.
- Good surface finish, improved chip control and less chattering



KING DRILL

Recommended cutting condition

Workpiece			Grade	vc	Feed(aspect ratio=2D, 3D, 4D)							
ISO	Workpiece	Hardness(HB)			Feed (mm/rev) depending on drill Dia.(mm)							
				m/min	12~16	17~23	24~29	30~42	43~60			
P	Carbon steel	Low carbon steel	LD	Central insert PC5335 Peripheral insert	150(60~180)	0.04~0.08	0.04~0.08	0.04~0.08	0.04~0.08	0.04~0.08		
			PD	Central insert PC5300 Peripheral insert PC3500	190(130~250)							
		High carbon	180~280	PD	Central insert PC5300 Peripheral insert PC3500	140(80~200)	0.04~0.10	0.04~0.12	0.05~0.16	0.08~0.18	0.10~0.22	
	Alloy steel	Low alloy steel	140~260	LD	Central insert PC5335 Peripheral insert	150(60~180)	0.04~0.10	0.04~0.10	0.04~0.12	0.04~0.14	0.04~0.14	
				PD	Central insert PC5300 Peripheral insert PC3500	150(90~200)	0.06~0.12	0.06~0.12	0.06~0.14	0.06~0.16	0.06~0.16	
			Hardened low alloy steel	200~400	PD	Central insert PC5300 Peripheral insert PC5300	100(50~150)	0.04~0.10	0.06~0.12	0.08~0.16	0.08~0.18	0.08~0.22
			High alloy steel	50~260	PD	Central insert PC5300 Peripheral insert PC3500	100(50~160)	0.04~0.18	0.06~0.12	0.08~0.16	0.08~0.18	0.08~0.22
			Hardened high alloy steel	220~450	PD	Central insert PC5300 Peripheral insert PC5300	70(30~120)	0.04~0.12	0.06~0.14	0.08~0.17	0.08~0.17	0.08~0.20
	M	Stainless steel	Austenite series	135~275	LD	Central insert PC5335 Peripheral insert	90(40~150)	0.04~0.10	0.04~0.12	0.04~0.12	0.04~0.12	0.04~0.12
					PD	Central insert PC5300 Peripheral insert PC5300		0.04~0.10	0.06~0.12	0.06~0.14	0.06~0.16	0.06~0.20
		Ferrite series Martensite series	135~275	LD	Central insert PC5335 Peripheral insert	100(60~160)	0.04~0.10	0.04~0.12	0.04~0.12	0.04~0.12	0.04~0.12	
PD				Central insert PC5300 Peripheral insert PC5300	0.04~0.10		0.04~0.12	0.06~0.14	0.06~0.14	0.06~0.14		
K	Cast iron	Gray cast iron	150~230	PD	Central insert PC5300 Peripheral insert PC6510	190(150~250)	0.04~0.10	0.05~0.14	0.06~0.18	0.10~0.22	0.10~0.26	
		Ductile cast iron	150~230	PD	Central insert PC5300 Peripheral insert PC6510	150(100~200)	0.04~0.10	0.04~0.12	0.04~0.14	0.05~0.16	0.05~0.18	
S	Heat resisting alloy	Ni-heat resisting alloy	130~400	PD	PC5300	50(30~100)	0.04~0.06	0.04~0.08	0.04~0.10	0.06~0.12	0.06~0.12	
		Ti-heat resisting alloy	130~400	PD	PC5300	40(30~90)	0.04~0.08	0.04~0.10	0.06~0.12	0.08~0.14	0.08~0.16	
		High hardened steel	Over 400	PD	PC5300	40(20~80)	0.04~0.08	0.06~0.12	40(20~80)	0.08~0.14	0.08~0.16	

- In case of 5D, reduce 30~40% of cutting condition from the above.
- In interrupted machining part, reduce 30~50% of feed from the above machining around interrupted part.

Required machine power

- The graphs below show the cutting force required in drilling.
- Machining with the KING DRILL and a machine with high rigidity and power

• Workpiece : SCM440(240HB) • Cutting condition : $vc(m/min)=100$
 • Through coolant system

$fn(mm/rev)=0.13$

$fn(mm/rev)=0.10$

$fn(mm/rev)=0.07$

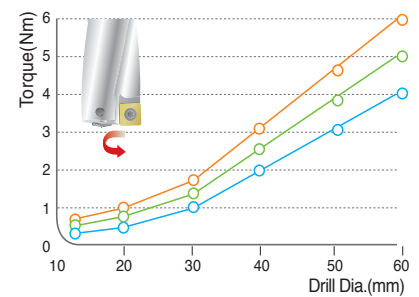
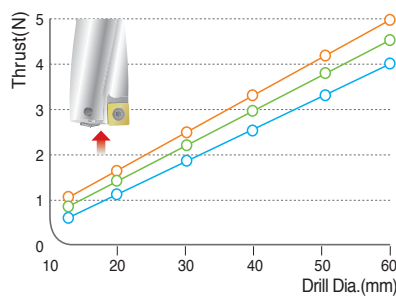
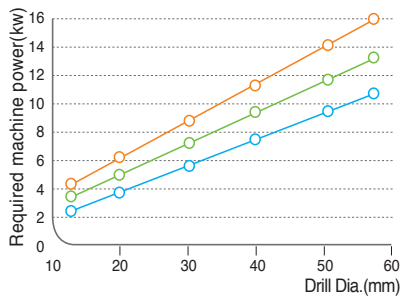

• Cutting oil quantity

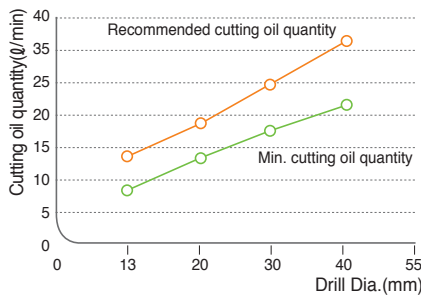

• Workpiece : SCM440(240HB)
 • Cutting condition : $vc(m/min)=100$
 • Through coolant system

- Recommended pressure of coolant : $5kg/cm^2$ above
- The data of the graph above could be changed depending on workpiece and cutting condition.



Drill tolerance and hole tolerance

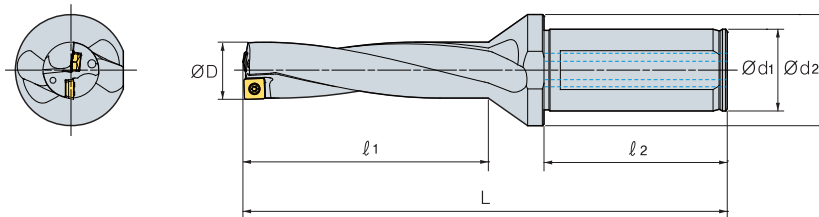

(mm)

Drill diameter		Ø12 ~ Ø29	Ø30 ~ Ø45	Ø46 ~ Ø60.5
2D~3D	Drill tolerance(ØD)	0 ~ -0.15	0 ~ -0.15	0 ~ -0.15
	Hole tolerance	+0.2 ~ -0.1	+0.25 ~ -0.1	+0.28 ~ -0.1
4D~5D	Drill tolerance(ØD)	0 ~ -0.15	0 ~ -0.15	0 ~ -0.15
	Hole tolerance	+0.25 ~ -0.05	+0.3 ~ -0.05	+0.33 ~ -0.05

- The actual hole tolerance of KING DRILL is as shown in the chart above.
- The length of drill, kind of workpiece, machine stability, and cutting condition could affect the hole tolerance.

KING DRILL



The shape of the bottom of blind hole

Drill diameter(mm)	Peripheral insert	Central insert	a
Ø12.0~Ø13.5	SPMT040204-□□	XOMT040204-□□	0.4
Ø13.6~Ø16.0	SPMT050204-□□	XOMT050204-□□	0.4
Ø16.1~Ø19.5	SPMT060205-□□	XOMT060204-□□	0.5
Ø19.6~Ø23.5	SPMT07T208-□□	XOMT07T205-□□	0.5
Ø23.6~Ø29.5	SPMT090308-□□	XOMT090305-□□	0.7
Ø29.6~Ø35.5	SPMT11T308-□□	XOMT11T306-□□	0.8
Ø35.6~Ø42.5	SPMT130410-□□	XOMT130406-□□	1.0
Ø42.6~Ø50.5	SPMT15M510-□□	XOMT15M508-□□	1.1
Ø50.6~Ø60.5	SPMT180510-□□	XOMT180508-□□	1.2

- KING DRILL drills with two inserts, central and peripheral
- Refer to the above chart for remaining insert curve of blind hole bottom.

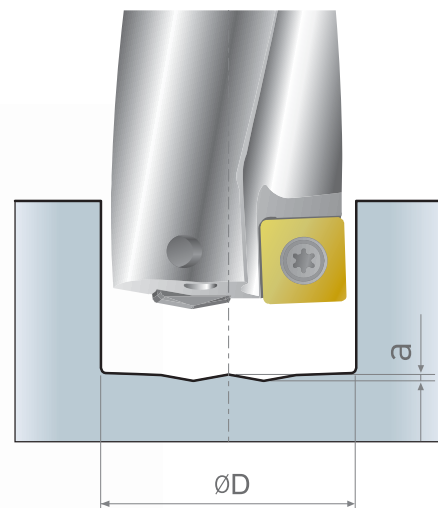
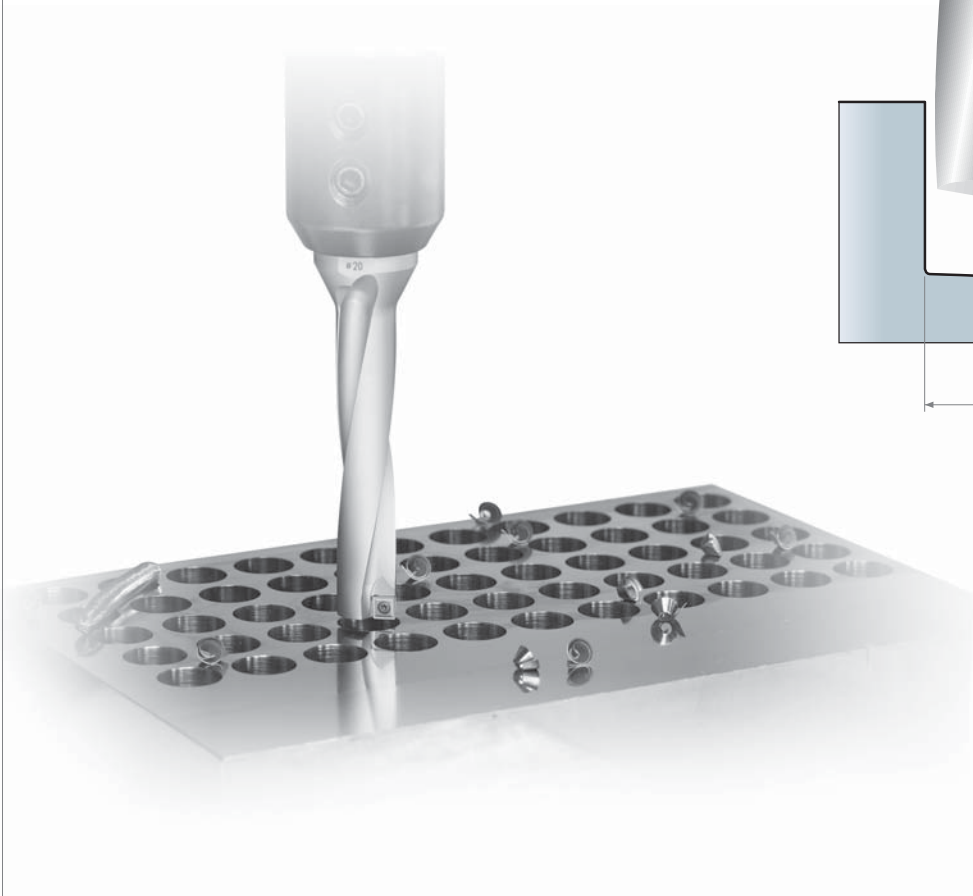

How to clamp KING DRILL to side lock arbor

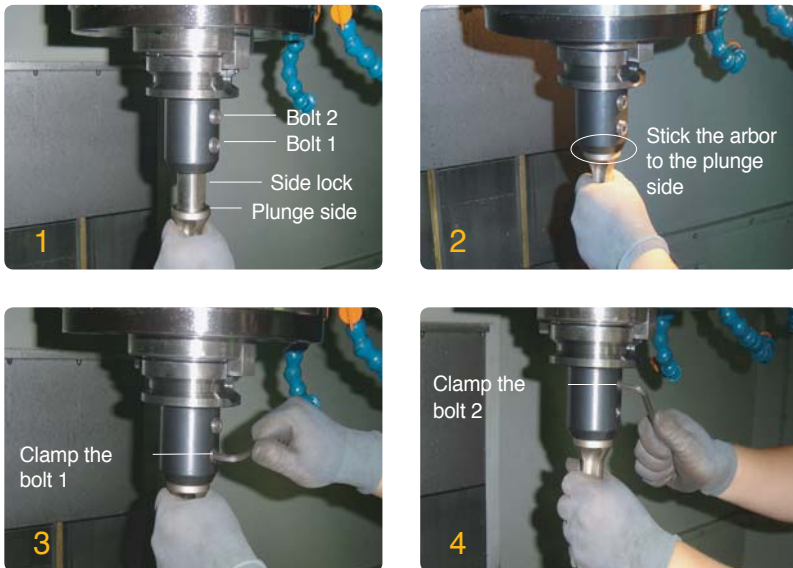

- Recommendation to use side lock arbor for KING DRILL
 1. Insert the part of side lock of drill to the same direction of clamping the bolt to the arbor
 2. Push the plunge side of drill into the arbor.
 3. Clamp the bolt 1 first.
 4. Next, clamp the bolt 2.

Notice for setting the drill in the lathe

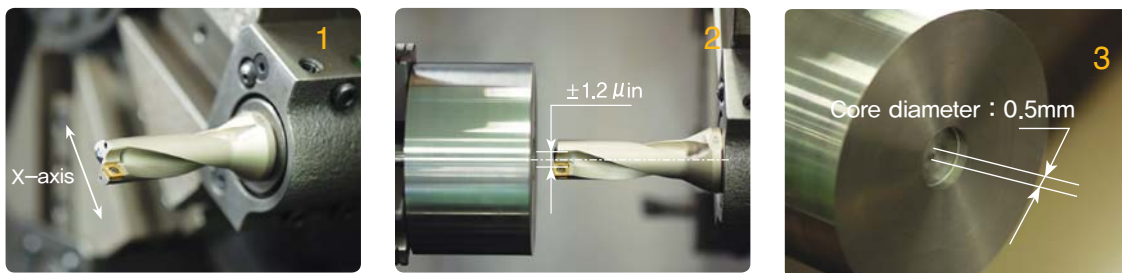





- Set the peripheral insert parallel to the X axis. (based on the side lock)
- If the machined core is 0.5mm after machining 5mm, that is the proper setting.
- * Please make sure that the location of the side lock could be different depending on manufacturers of machine.

KING DRILL

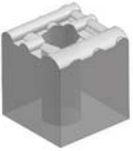
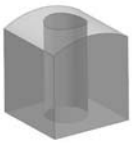

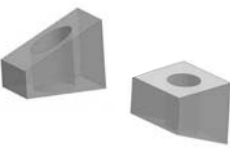
Machining required attention

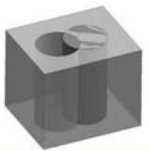
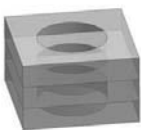
Workpiece	Machining	
	Machining irregular face	<ul style="list-style-type: none"> • Possible chipping and fracture of the insert • Reduce normal feed 25%.
	Machining convex side	<ul style="list-style-type: none"> • Possible initial contact with central insert • Reduce feed 50% until both inserts are engaged.
	Machining concave side	<ul style="list-style-type: none"> • Reduce feed 50% until both inserts are engaged.
	Boring	<ul style="list-style-type: none"> • Reduce feed 50% from normal conditions.
	Ramping	<ul style="list-style-type: none"> • Reduce feed 50% from normal conditions.
	Machining cross holes	<ul style="list-style-type: none"> • Reduce feed 50% in the overlapped section.
	Machining overlapped holes	<ul style="list-style-type: none"> • Reduce feed 50% from normal conditions.
	Machining overlapped panels	<ul style="list-style-type: none"> • Possible chipping and fracture of insert • Reduce normal feed 25%.

Solutions for machining failure

Failure	Detail	Solution
Different diameters of one machined hole	Different diameters of one machined hole → The end of hole diameter is bigger.	<ul style="list-style-type: none"> • Use more coolant and check the coolant evacuation. • Change the drill to one with small aspect ratio. • Change the cutting condition for better chip control.
Enlarging or reducing hole diameter	Enlarging or reducing hole diameter	<ul style="list-style-type: none"> • Milling → Use more coolant. → Check the coolant evacuation. • Turning → Check the center of drill and workpiece. → Rotate the drill to 180°.
Chattering	Vibration while machining	<ul style="list-style-type: none"> • Set the overhang of drill short. • Reduce the cutting speed and feed. • Stable clamping • Check the torque of machine.
Poor chip evacuation	Long chip	<ul style="list-style-type: none"> • Mild steel / STS → speed up, feed down. • Alloy steel / carbon steel → speed up, feed up.
	Short chip	<ul style="list-style-type: none"> • Speed down, feed down, pressure of coolant up.
Poor surface finish	Scratch on the machined side	<ul style="list-style-type: none"> • Set the cutting condition for better chip control. • Feed down or speed up. • Increase the coolant flow and check the coolant evacuation. • Set the overhang of drill short and more stable clampin.
Short tool life of insert	Too much wear or chipping on insert	<ul style="list-style-type: none"> • Check the cutting condition. • Use more coolant and check the coolant evacuation. • Set the overhang of drill short and more stable clamping. • Change the insert grade.

Insert and parts

Drill diameter	Peripheral insert	Central insert	Screw	Wernch	Torque(μm)
Ø12.0~Ø13.5	SPMT040204-□□	XOMT040204-□□	FTNA0204	TW06P	0.4
Ø13.6~Ø16.0	SPMT050204-□□	XOMT050204-□□	FTNA0204	TW06P	0.4
Ø16.1~Ø19.5	SPMT060205-□□	XOMT060204-□□	FTKA02206S	TW07P	0.8
Ø19.6~Ø23.5	SPMT07T208-□□	XOMT07T205-□□	FTKA02565	TW07S	0.8
Ø23.6~Ø29.5	SPMT090308-□□	XOMT090305-□□	FTKA0307	TW09S	1.2
Ø29.6~Ø35.5	SPMT11T308-□□	XOMT11T306-□□	FTKA03508	TW15S	3
Ø35.6~Ø42.5	SPMT130410-□□	XOMT130406-□□	FTKA0410	TW15S	3
Ø42.6~Ø50.5	SPMT15M510-□□	XOMT15M508-□□	FTNC04511	TW20S	5
Ø50.6~Ø60.5	SPMT180510-□□	XOMT180508-□□	FTNA0511	TW20-100	5

- In clamping an insert, please clean the tip seat and apply CASMOLY1000 on the screw.
- Please make sure to use a Korloy-produced wrench and screw only.

KING DRILL

Special drill order form (Mark 'V' in the box)

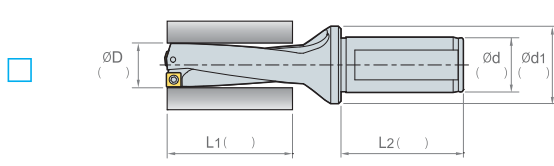
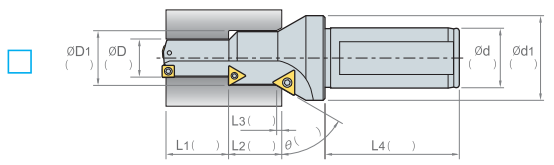
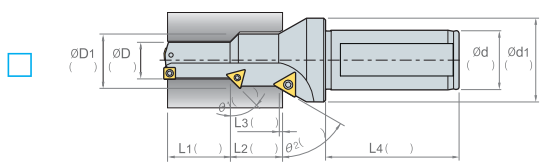
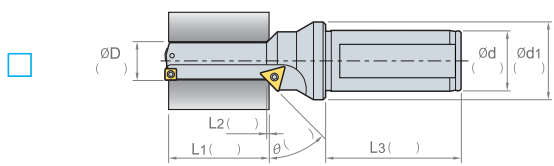
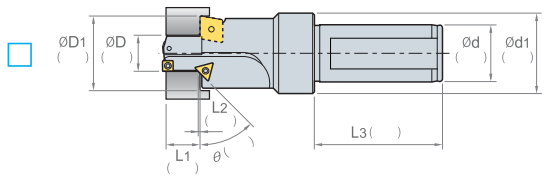

• Note

- Currently using tool :
- Current cutting condition
 - RPM or $vc(m/min)$:
 - $vf(mm/min)$ or $fn(mm/rev)$:
 - Depth of cut(mm) :
- standard of measuring tool life :
- Currently using machine
 - Machining center :
 - General lathe :
 - CNC lathe :

• Coolant type

- Oil hole on the plunge part Oil hole on the shank

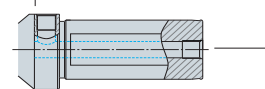

• Hole type

- Blind hole
 Thru hole

• Types of shank

- (Flat type)
- (Weldon type)
- (Whistle Notch type)

• Location of side lock

- Parallel to peripheral insert(standard)

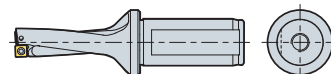

- 90° angle to peripheral insert

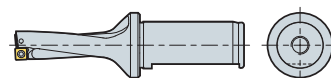

- 150° angle to peripheral insert

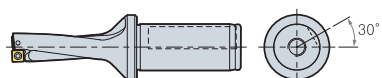

- 180° angle to peripheral insert

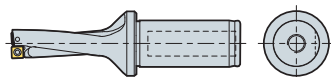

Drill with through coolant system for general lathe and CNC lathe
without through coolant system

KING DRILL (for through coolant system with a lathe)

- Through coolant system with drill holder, plug, oil-hole hose and oil-hole pump
- PT Tap in the plug is combined to PT Tap connected to oil hose.
- Available to use the drill without a plug in milling machine

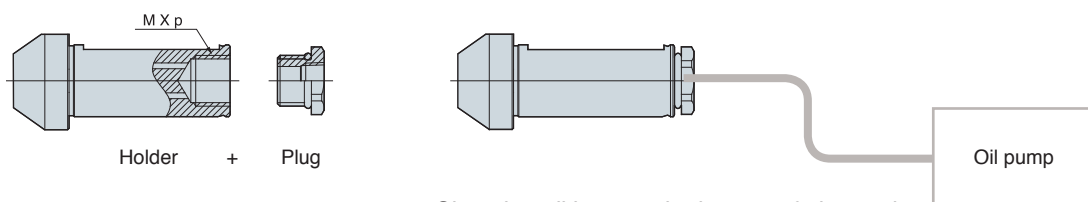

- Clamping oil hose to the bottom of plug and connect the oil pump to the holder

(mm)

Designation	Diameter	Shank Dia.	M x p	Plug
K□D120~16020HP-□□	Ø12.0 ~ Ø16.0	Ø20	M12 x 1.5	PLG12PT18
K□D161~23525HP-□□	Ø16.1 ~ Ø23.5	Ø25	M16 x 1.5	PLG16PT18
K□D236~35532HP-□□	Ø23.6 ~ Ø35.5	Ø32	M20 x 2.0	PLG20PT14
K□D356~60940HP-□□	Ø35.6 ~ Ø60.5	Ø40	M27 x 2.0	PLG27PT38

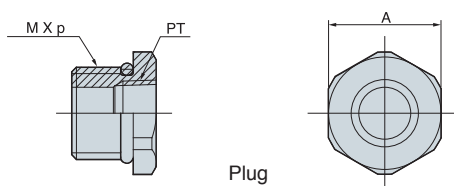

- Plug is assembled.

Plug Type	M x p (Metric)	PT Tap	A
PLG12PT18	M12 x 1.5	1/8	16
PLG16PT18	M16 x 1.5	1/8	19
PLG20PT14	M20 x 2.0	1/4	26
PLG27PT38	M27 x 2.0	3/8	35

KING DRILL

High rigidity drill produces cost efficiency due to cartridge replacement.

KING DRILL (for large diameter drilling)

- Cartridge type for $\varnothing 61\sim\varnothing 100$ drilling
- Peripheral cartridge can adjust the drilling diameter within 5mm.
- Easy to adjust drilling diameter with adjusting bolt

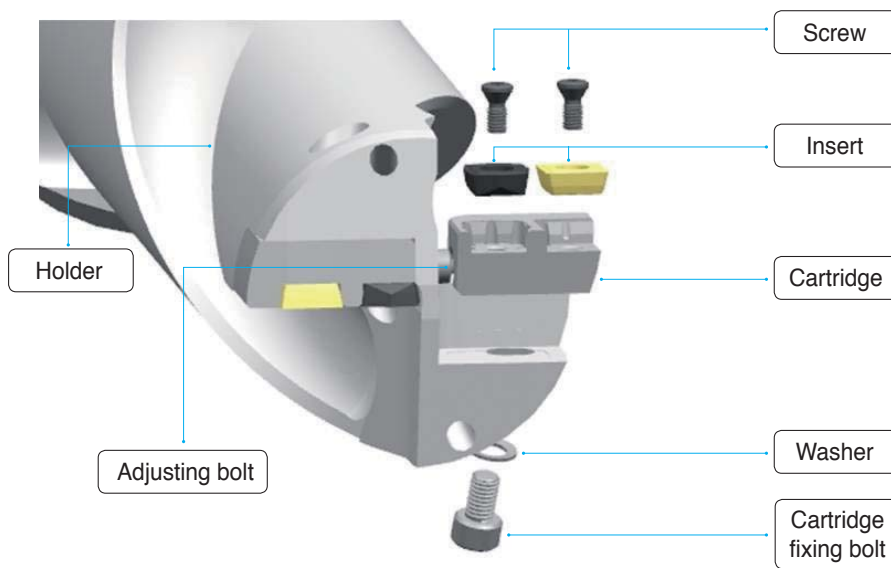

• Adjustment of drill diameter

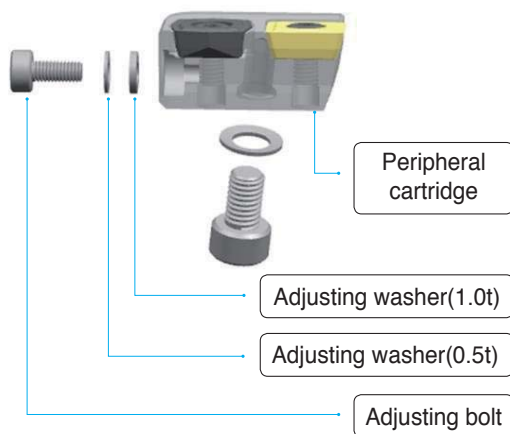

Adjustment(mm) \varnothing (mm)	Adjusting Washer	
	Designation	Width(mm)
1	WA0305	0.5
2	WA0310	1.0
3	WA0305 + WA0310	1.5
4	WA0310 x 2	2.0
5	WA0305 + WA0310 x 2	2.5

* Adjusting washer adjusts the drilling diameter within 5mm.



Insert

• SPMT-LD

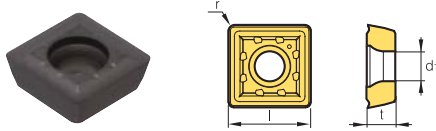

• SPMT-PD

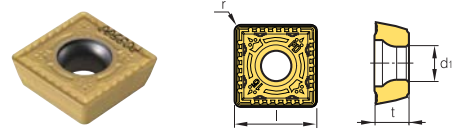

(mm)

Drill diameter	Designation		Grade	l	t	r	d ₁	
Ø16.1 ~ Ø19.5	SPMT	060205-LD	PC5335	6.2	2.5	0.5	2.5	
Ø19.6 ~ Ø23.5		07T208-LD		7.5	2.8	0.7	2.8	
Ø23.6 ~ Ø29.5		090308-LD		9.2	3.3	0.8	3.4	
Ø29.6 ~ Ø35.5		11T308-LD		11.0	4.0	0.8	4.0	
Ø35.6 ~ Ø42.5		130410-LD		13.0	4.5	1.0	4.5	
Ø42.6 ~ Ø50.5		15M510-LD		15.2	5.0	1.0	5.5	
Ø50.6 ~ Ø60.5		180510-LD		18.2	5.5	1.0	6.0	
Ø12.0 ~ Ø13.5	SPMT	040204-PD	PC5300	4.7	2.4	0.4	2.3	
Ø13.6 ~ Ø16.0		050204-PD		5.1	2.4	0.4	2.3	
Ø16.1 ~ Ø19.5		060205-PD		6.2	2.5	0.5	2.5	
Ø19.6 ~ Ø23.5		07T208-PD	7.5	2.8	0.7	2.8		
Ø23.6 ~ Ø29.5		090308-PD	9.2	3.3	0.8	3.4		
Ø29.6 ~ Ø35.5		11T308-PD	11.0	4.0	0.8	4.0		
Ø35.6 ~ Ø42.5		130410-PD	13.0	4.5	1.0	4.5		
Ø42.6 ~ Ø50.5		15M510-PD	15.2	5.0	1.0	5.5		
Ø50.6 ~ Ø60.5		180510-PD	18.2	5.5	1.0	6.0		
				PC3500				
				PC6510				

• XOMT-LD

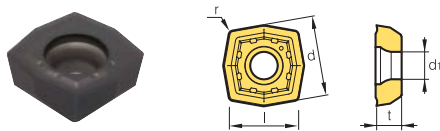

• XOMT-PD

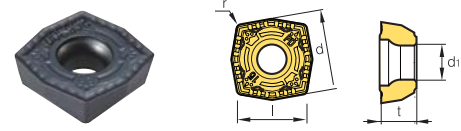

(mm)



Drill diameter	Designation		Grade	l	d	t	r	d ₁
Ø16.1 ~ Ø19.5	XOMT	060204-LD	PC5335	5.8	6.6	2.5	0.4	2.5
Ø19.6 ~ Ø23.5		07T205-LD		6.9	7.8	2.8	0.5	2.8
Ø23.6 ~ Ø29.5		090305-LD		8.4	9.6	3.3	0.5	3.4
Ø29.6 ~ Ø35.5		11T306-LD		10.0	11.4	4.0	0.6	4.0
Ø35.6 ~ Ø42.5		130406-LD		11.9	13.6	4.5	0.6	4.5
Ø42.6 ~ Ø50.5		15M508-LD		13.9	15.9	5.0	0.8	5.5
Ø50.6 ~ Ø60.5		180508-LD		16.5	18.9	5.5	0.8	6.0
Ø12.0 ~ Ø13.5	XOMT	040204-PD	PC5300	4.3	4.9	2.4	0.4	2.3
Ø13.6 ~ Ø16.0		050204-PD		4.8	5.4	2.4	0.4	2.3
Ø16.1 ~ Ø19.5		060204-PD		5.8	6.6	2.5	0.4	2.5
Ø19.6 ~ Ø23.5		07T205-PD		6.9	7.8	2.8	0.5	2.8
Ø23.6 ~ Ø29.5		090305-PD		8.4	9.6	3.3	0.5	3.4
Ø29.6 ~ Ø35.5		11T306-PD		10.0	11.4	4.0	0.6	4.0
Ø35.6 ~ Ø42.5		130406-PD		11.9	13.6	4.5	0.6	4.5
Ø42.6 ~ Ø50.5		15M508-PD		13.9	15.9	5.0	0.8	5.5
Ø50.6 ~ Ø60.5		180508-PD		16.5	18.9	5.5	0.8	6.0

KING DRILL

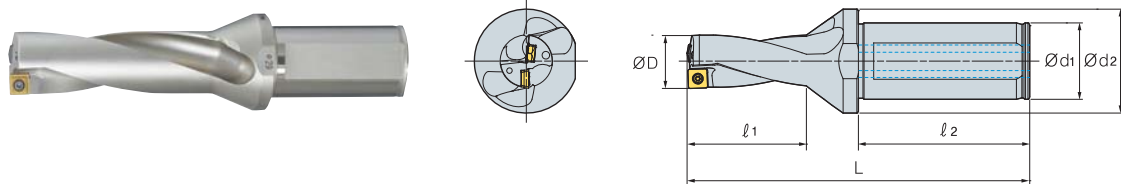
KING DRILL-2D



(mm)

Designaton	ØD	Ød1	Ød2	l ₁	l ₂	L	Insert	Screw 	Wrech 
K2D	12020-04	12.0	20	25	27	50	SPMT040204-PD XOMT040204-PD	FTNA0204	TW06P
	12520-04	12.5	20	25	27	50			
	13020-04	13.0	20	25	29	50			
	13520-04	13.5	20	25	29	50	SPMT050204-PD XOMT050204-PD	FTNA0204	TW06P
	14020-05	14.0	20	25	31	50			
	14520-05	14.5	20	25	31	50			
	15020-05	15.0	20	25	33	50	SPMT060205-PD XOMT060204-PD	FTKA02206S	TW07P
	15520-05	15.5	20	25	33	50			
	16020-05	16.0	20	25	35	50			
	16525-06	16.5	25	34	35	56	SPMT07T208-PD XOMT07T205-PD	FTKA02565	TW07S
	17025-06	17.0	25	34	37	56			
	17525-06	17.5	25	34	37	56			
	18025-06	18.0	25	34	39	56	SPMT090308-PD XOMT090305-PD	FTKA0307	TW09S
	18525-06	18.5	25	34	39	56			
	19025-06	19.0	25	34	41	56			
	19525-06	19.5	25	34	41	56	SPMT090308-PD XOMT090305-PD	FTKA0307	TW09S
	20025-07	20.0	25	34	43	56			
	20525-07	20.5	25	34	43	56			
	21025-07	21.0	25	34	45	56	SPMT090308-PD XOMT090305-PD	FTKA0307	TW09S
	21525-07	21.5	25	34	45	56			
	22025-07	22.0	25	34	47	56			
	22525-07	22.5	25	34	47	56	SPMT090308-PD XOMT090305-PD	FTKA0307	TW09S
	23025-07	23.0	25	34	49	56			
	23525-07	23.5	25	34	49	56			
	24032-09	24.0	32	44	51	60	SPMT090308-PD XOMT090305-PD	FTKA0307	TW09S
	24532-09	24.5	32	44	51	60			
	25032-09	25.0	32	44	53	60			
	25532-09	25.5	32	44	53	60	SPMT090308-PD XOMT090305-PD	FTKA0307	TW09S
	26032-09	26.0	32	44	55	60			
	26532-09	26.5	32	44	55	60			
	27032-09	27.0	32	44	57	60	SPMT090308-PD XOMT090305-PD	FTKA0307	TW09S
	27532-09	27.5	32	44	57	60			
28032-09	28.0	32	44	59	60				
28532-09	28.5	32	44	59	60	SPMT090308-PD XOMT090305-PD	FTKA0307	TW09S	
29032-09	29.0	32	44	61	60				
29532-09	29.5	32	44	61	60				

KING DRILL-2D

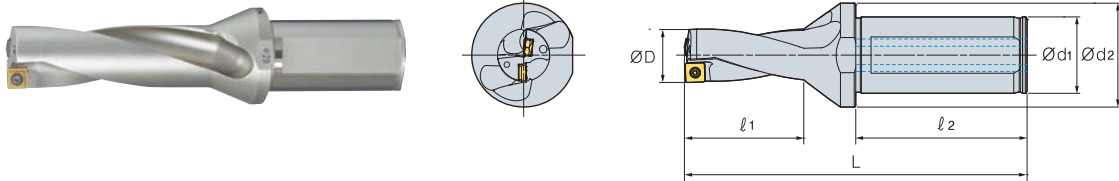

(mm)

Designaton	ØD	Ød1	Ød2	l ₁	l ₂	L	Insert	Screw	Wrech
K2D	30032-11	30.0	32	44	63	60	SPMT11T308-PD XOMT11T306-PD	FTKA03508	TW15S
	30532-11	30.5	32	44	63	60			
	31032-11	31.0	32	44	65	60			
	31532-11	31.5	32	44	65	60			
	32032-11	32.0	32	44	67	60			
	32532-11	32.5	32	44	67	60			
	33032-11	33.0	32	44	69	60			
	33532-11	33.5	32	44	69	60			
	34032-11	34.0	32	44	71	60			
	34532-11	34.5	32	44	71	60			
	35032-11	35.0	32	44	73	60			
	35532-11	35.5	32	44	73	60			
	36040-13	36.0	40	48	76	70			
36540-13	36.5	40	48	76	70				
37040-13	37.0	40	48	78	70				
37540-13	37.5	40	48	78	70				
38040-13	38.0	40	48	80	70				
38540-13	38.5	40	48	80	70				
39040-13	39.0	40	48	82	70				
39540-13	39.5	40	48	82	70				
40040-13	40.0	40	48	84	70				
40540-13	40.5	40	48	84	70				
41040-13	41.0	40	48	86	70				
41540-13	41.5	40	48	86	70				
42040-13	42.0	40	48	88	70				
42540-13	42.5	40	48	88	70				
43040-15	43.0	40	58	91	70	SPMT15M510-PD XOMT15M508-PD	FTNC04511	TW20S	
43540-15	43.5	40	58	91	70				
44040-15	44.0	40	58	93	70				
44540-15	44.5	40	58	93	70				
45040-15	45.0	40	58	95	70				
45540-15	45.5	40	58	95	70				
46040-15	46.0	40	58	97	70				
46540-15	46.5	40	58	97	70				
47040-15	47.0	40	58	99	70				
47540-15	47.5	40	58	99	70				

KING DRILL

KING DRILL-2D

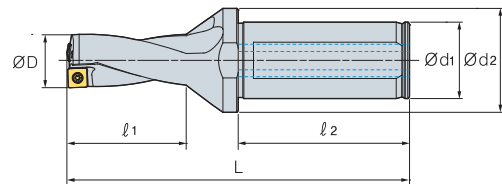
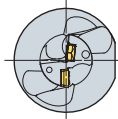

(mm)

Designaton	ØD	Ød1	Ød2	l ₁	l ₂	L	Insert	Screw	Wrech
K2D	48040-15	48.0	40	58	101	70	SPMT15M510-PD XOMT15M508-PD	FTNC04511	TW20S
	48540-15	48.5	40	58	101	70			
	49040-15	49.0	40	58	103	70			
	49540-15	49.5	40	58	103	70			
	50040-15	50.0	40	58	105	70			
	50540-15	50.5	40	58	105	70			
	51040-18	51.0	40	68	108	70	SPMT180510-PD XOMT180508-PD	FTNA0511	TW20-100
	51540-18	51.5	40	68	108	70			
	52040-18	52.0	40	68	110	70			
	52540-18	52.5	40	68	110	70			
	53040-18	53.0	40	68	112	70			
	53540-18	53.5	40	68	112	70			
	54040-18	54.0	40	68	114	70			
	54540-18	54.5	40	68	114	70			
	55040-18	55.0	40	68	116	70			
	55540-18	55.5	40	68	116	70			
	56040-18	56.0	40	68	118	70			
	56540-18	56.5	40	68	118	70			
	57040-18	57.0	40	68	121	70			
	57540-18	57.5	40	68	121	70			
58040-18	58.0	40	68	124	70				
58540-18	58.5	40	68	124	70				
59040-18	59.0	40	68	127	70				
59540-18	59.5	40	68	127	70				
60040-18	60.0	40	68	130	70				
60540-18	60.5	40	68	130	70				

KING DRILL-3D

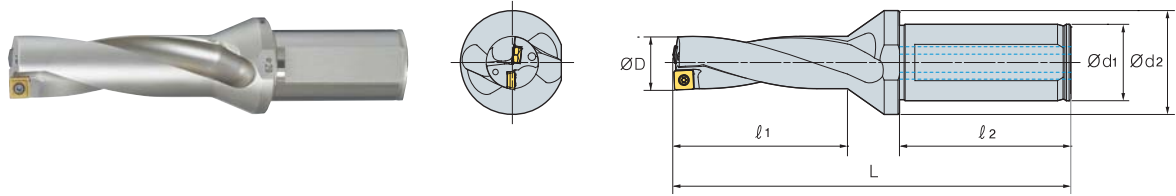

(mm)

Designaton	ØD	Ød1	Ød2	l ₁	l ₂	L	Insert	Screw	Wrech
K3D 12020-04*	12.0	20	25	39	50	103	SPMT040204-PD XOMT040204-PD	FTNA0204	TW06P
12220-04	12.2	20	25	39	50	103			
12520-04	12.5	20	25	39	50	103			
12920-04	12.9	20	25	42	50	106			
13020-04	13.0	20	25	42	50	106			
13520-04	13.5	20	25	42	50	106			
14020-05*	14.0	20	25	45	50	110	SPMT050204-PD XOMT050204-PD	FTNA0204	TW06P
14520-05	14.5	20	25	45	50	110			
15020-05	15.0	20	25	48	50	114			
15520-05*	15.5	20	25	48	50	114			
16020-05	16.0	20	25	51	50	117			
16525-06	16.5	25	34	51	56	123	SPMT060205-PD XOMT060204-PD	FTKA02206S	TW07P
17025-06	17.0	25	34	54	56	126			
17525-06*	17.5	25	34	54	56	126			
18025-06	18.0	25	34	57	56	130			
18525-06	18.5	25	34	57	56	130			
19025-06	19.0	25	34	60	56	133			
19525-06*	19.5	25	34	60	56	133			
20025-07	20.0	25	34	63	56	138	SPMT07T208-PD XOMT07T205-PD	FTKA02565	TW07S
20525-07	20.5	25	34	63	56	138			
21025-07*	21.0	25	34	66	56	141			
21525-07	21.5	25	34	66	56	141			
22025-07	22.0	25	34	69	56	144			
22525-07	22.5	25	34	69	56	144			
23025-07	23	25	34	72	56	149			
23525-07	23.5	25	34	72	56	149			
24032-09*	24.0	32	44	75	60	157	SPMT090308-PD XOMT090305-PD	FTKA0307	TW09S
24532-09	24.5	32	44	75	60	157			
25032-09	25.0	32	44	78	60	160			
25532-09	25.5	32	44	78	60	160			
26032-09	26.0	32	44	81	60	163			
26532-09*	26.5	32	44	81	60	163			
27032-09	27.0	32	44	84	60	167			
27532-09	27.5	32	44	84	60	167			
28032-09	28.0	32	44	87	60	171			
28532-09	28.5	32	44	87	60	171			
29032-09*	29.0	32	44	90	60	174			
29532-09	29.5	32	44	90	60	174			



The items marked * can machine a tap foundation hole.

KING DRILL

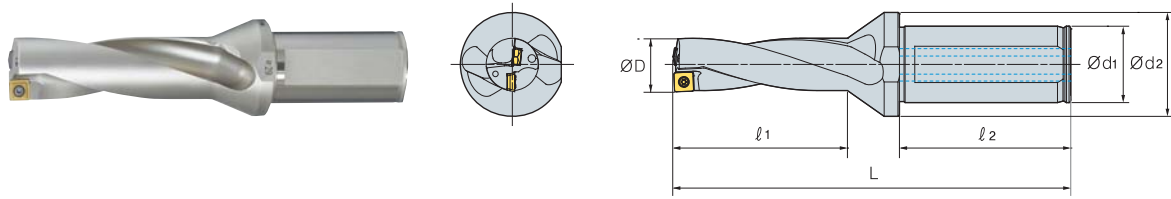
KING DRILL-3D



(mm)



Designaton	ØD	Ød1	Ød2	l ₁	l ₂	L	Insert	Screw 	Wrech 
K3D 30032-11*	30.0	32	44	93	60	180	SPMT11T308-PD XOMT11T306-PD	FTKA03508	TW15S
30532-11	30.5	32	44	93	60	180			
31032-11	31.0	32	44	96	60	183			
31532-11	31.5	32	44	96	60	183			
32032-11	32.0	32	44	99	60	186			
32532-11	32.5	32	44	99	60	186			
33032-11	33.0	32	44	102	60	190			
33532-11	33.5	32	44	102	60	190			
34032-11	34.0	32	44	105	60	193			
34532-11	34.5	32	44	105	60	193			
35032-11*	35.0	32	44	108	60	196			
35532-11	35.5	32	44	108	60	196			
36040-13	36.0	40	48	112	70	212			
36540-13	36.5	40	48	112	70	212			
37040-13	37.0	40	48	115	70	215			
37540-13	37.5	40	48	115	70	215			
38040-13	38.0	40	48	118	70	219			
38540-13	38.5	40	48	118	70	219			
39040-13	39.0	40	48	121	70	222			
39540-13	39.5	40	48	121	70	222			
40040-13	40.0	40	48	124	70	226			
40540-13	40.5	40	48	124	70	226			
41040-13	41.0	40	48	127	70	229			
41540-13	41.5	40	48	127	70	229			
42040-13	42.0	40	48	130	70	233			
42540-13	42.5	40	48	130	70	233			
43040-15	43.0	40	58	134	70	239			
43540-15	43.5	40	58	134	70	239			
44040-15	44.0	40	58	137	70	242			
44540-15	44.5	40	58	137	70	242			
45040-15	45.0	40	58	140	70	246			
45540-15	45.5	40	58	140	70	246			
46040-15	46.0	40	58	143	70	249			
46540-15	46.5	40	58	143	70	249			
47040-15	47.0	40	58	146	70	253			
47540-15	47.5	40	58	146	70	253			
48040-15	48.0	40	58	149	70	256			
48540-15	48.5	40	58	149	70	256			
							SPMT130410-PD XOMT130406-PD	FTKA0410	TW15S
							SPMT15M510-PD XOMT15M508-PD	FTNC04511	TW20S

The items marked * can machine a tap foundation hole.

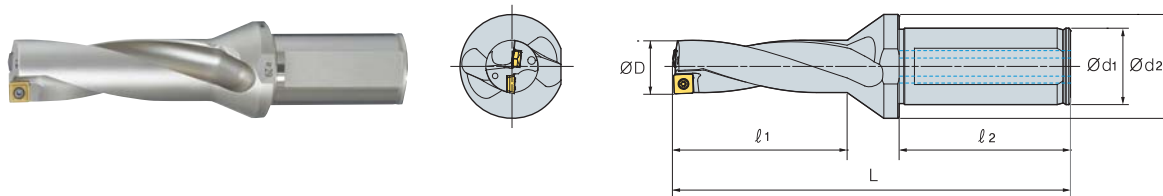
KING DRILL-3D



(mm)

Designaton	ØD	Ød1	Ød2	l ₁	l ₂	L	Insert	Screw 	Wrech 
K3D	49040-15	49.0	40	58	152	70	SPMT15M510-PD XOMT15M508-PD	FTNC04511	TW20S
	49540-15	49.5	40	58	152	70			
	50040-15	50.0	40	58	155	70			
	50540-15	50.5	40	58	155	70			
	51040-18	51.0	40	68	159	70			
	51540-18	51.5	40	68	159	70	SPMT180510-PD XOMT180508-PD	FTNA0511	TW20-100
	52040-18	52.0	40	68	162	70			
	52540-18	52.5	40	68	162	70			
	53040-18	53.0	40	68	165	70			
	53540-18	53.5	40	68	165	70			
	54040-18	54.0	40	68	168	70			
	54540-18	54.5	40	68	168	70			
	55040-18	55.0	40	68	171	70			
	55540-18	55.5	40	68	171	70			
	56040-18	56.0	40	68	174	70			
	56540-18	56.5	40	68	174	70			
	57040-18	57.0	40	68	178	70			
	57540-18	57.5	40	68	178	70			
	58040-18	58.0	40	68	182	70			
	58540-18	58.5	40	68	182	70			
59040-18	59.0	40	68	186	70				
59540-18	59.5	40	68	186	70				
60040-18	60.0	40	68	190	70				
60540-18	60.5	40	68	190	70				

KING DRILL

KING DRILL-4D

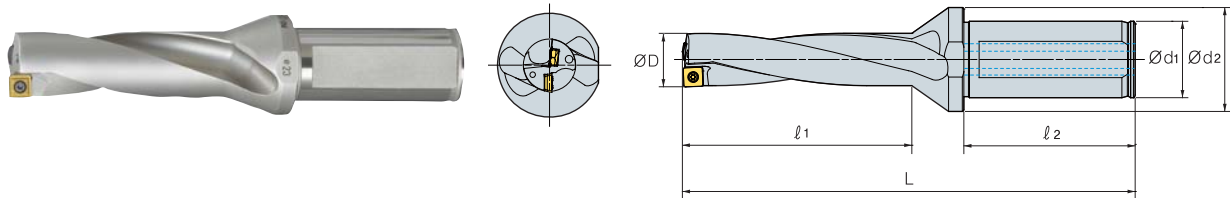

(mm)

Designaton	ØD	Ød1	Ød2	l ₁	l ₂	L	Insert	Screw	Wrech	
K4D	12020-04	12.0	20	25	51	50	115	SPMT040204-PD XOMT040204-PD	FTNA0204	TW06P
	12520-04	12.5	20	25	51	50	115			
	13020-04	13.0	20	25	55	50	119			
	13520-04	13.5	20	25	55	50	119			
	14020-05	14.0	20	25	59	50	124	SPMT050204-PD XOMT050204-PD	FTNA0204	TW06P
	14520-05	14.5	20	25	59	50	124			
	15020-05	15.0	20	25	63	50	129			
	15520-05	15.5	20	25	63	50	129			
	16020-05	16.0	20	25	67	50	133	SPMT060205-PD XOMT060204-PD	FTKA02206S	TW07P
	16525-06	16.5	25	34	67	56	139			
	17025-06	17.0	25	34	71	56	143			
	17525-06	17.5	25	34	71	56	143			
	18025-06	18.0	25	34	75	56	148			
	18525-06	18.5	25	34	75	56	148			
	19025-06	19.0	25	34	79	56	152	SPMT07T208-PD XOMT07T205-PD	FTKA02565	TW07S
	19525-06	19.5	25	34	79	56	152			
	20025-07	20.0	25	34	83	56	158			
	20525-07	20.5	25	34	83	56	158			
	21025-07	21.0	25	34	87	56	162			
	21525-07	21.5	25	34	87	56	162			
	22025-07	22.0	25	34	91	56	166	SPMT090308-PD XOMT090305-PD	FTKA0307	TW09S
	22525-07	22.5	25	34	91	56	166			
	23025-07	23.0	25	34	95	56	172			
	23525-07	23.5	25	34	95	56	172			
	24032-09	24.0	32	44	99	60	181			
	24532-09	24.5	32	44	99	60	181			
	25032-09	25.0	32	44	103	60	185			
	25532-09	25.5	32	44	103	60	185			
	26032-09	26.0	32	44	107	60	189			
	26532-09	26.5	32	44	107	60	189			
	27032-09	27.0	32	44	111	60	194			
	27532-09	27.5	32	44	111	60	194			
28032-09	28.0	32	44	115	60	199				
28532-09	28.5	32	44	115	60	199				
29032-09	29.0	32	44	119	60	203				
29532-09	29.5	32	44	119	60	203				

KING DRILL-4D

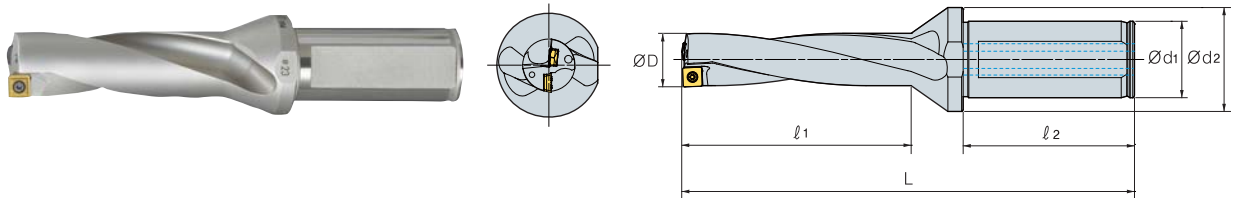

(mm)



Designaton	ØD	Ød1	Ød2	l ₁	l ₂	L	Insert	Screw	Wrech
K4D	30032-11	30.0	32	44	123	60	SPMT11T308-PD XOMT11T306-PD	FTKA03508	TW15S
	30532-11	30.5	32	44	123	60			
	31032-11	31.0	32	44	127	60			
	31532-11	31.5	32	44	127	60			
	32032-11	32.0	32	44	131	60			
	32532-11	32.5	32	44	131	60			
	33032-11	33.0	32	44	135	60			
	33532-11	33.5	32	44	135	60			
	34032-11	34.0	32	44	139	60			
	34532-11	34.5	32	44	139	60			
	35032-11	35.0	32	44	143	60			
	35532-11	35.5	32	44	143	60			
36040-13	36.0	40	48	148	70	SPMT130410-PD XOMT130406-PD	FTKA0410	TW15S	
36540-13	36.5	40	48	148	70				
37040-13	37.0	40	48	152	70				
37540-13	37.5	40	48	152	70				
38040-13	38.0	40	48	156	70				
38540-13	38.5	40	48	156	70				
39040-13	39.0	40	48	160	70				
39540-13	39.5	40	48	160	70				
40040-13	40.0	40	48	164	70				
40540-13	40.5	40	48	164	70				
41040-13	41.0	40	48	168	70				
41540-13	41.5	40	48	168	70				
42040-13	42.0	40	48	172	70	SPMT15M510-PD XOMT15M508-PD	FTNC04511	TW20S	
42540-13	42.5	40	48	172	70				
43040-15	43.0	40	58	177	70				
43540-15	43.5	40	58	177	70				
44040-15	44.0	40	58	181	70				
44540-15	44.5	40	58	181	70				
45040-15	45.0	40	58	185	70				
45540-15	45.5	40	58	185	70				
46040-15	46.0	40	58	189	70				
46540-15	46.5	40	58	189	70				
47040-15	47.0	40	58	193	70				
47540-15	47.5	40	58	193	70				

KING DRILL

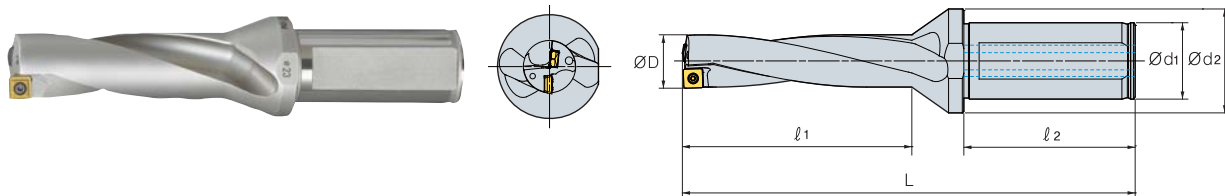
KING DRILL-4D



(mm)

Designaton	ØD	Ød1	Ød2	l1	l2	L	Insert	Screw 	Wrech 
K4D	48040-15	48.0	40	58	197	70	SPMT15M510-PD XOMT15M508-PD	FTNC04511	TW20S
	48540-15	48.5	40	58	197	70			
	49040-15	49.0	40	58	201	70			
	49540-15	49.5	40	58	201	70			
	50040-15	50.0	40	58	205	70			
	50540-15	50.5	40	58	205	70			
	51040-18	51.0	40	68	210	70	SPMT180510-PD XOMT180508-PD	FTNA0511	TW20-100
	51540-18	51.5	40	68	210	70			
	52040-18	52.0	40	68	214	70			
	52540-18	52.5	40	68	214	70			
	53040-18	53.0	40	68	218	70			
	53540-18	53.5	40	68	218	70			
	54040-18	54.0	40	68	222	70			
	54540-18	54.5	40	68	222	70			
	55040-18	55.0	40	68	226	70			
	55540-18	55.5	40	68	226	70			
	56040-18	56.0	40	68	230	70			
	56540-18	56.5	40	68	230	70			
	57040-18	57.0	40	68	235	70			
	57540-18	57.5	40	68	235	70			
58040-18	58.0	40	68	240	70				
58540-18	58.5	40	68	240	70				
59040-18	59.0	40	68	245	70				
59540-18	59.5	40	68	245	70				
60040-18	60.0	40	68	250	70				
60540-18	60.5	40	68	250	70				

KING DRILL-5D

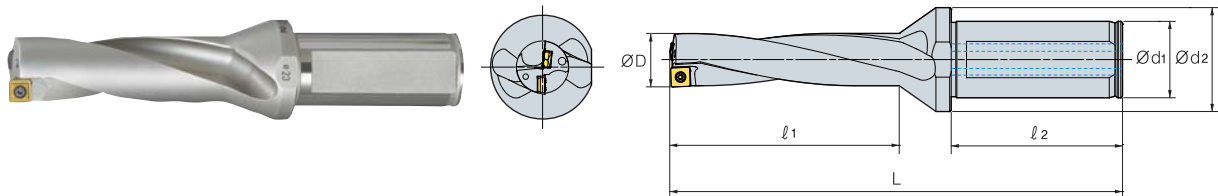

Designaton		ØD	Ød1	Ød2	l ₁	l ₂	L	Insert	Screw	Wrech
K5D	12020-04	12.0	20	25	63	50	127	SPMT040204-PD XOMT040204-PD	FTNA0204	TW06P
	12520-04	12.5	20	25	63	50	127			
	13020-04	13.0	20	25	68	50	132			
	13520-04	13.5	20	25	68	50	132	SPMT050204-PD XOMT050204-PD	FTNA0204	TW06P
	14020-05	14.0	20	25	73	50	138			
	14520-05	14.5	20	25	73	50	138			
	15020-05	15.0	20	25	78	50	144			
	15520-05	15.5	20	25	78	50	144			
	16020-05	16.0	20	25	83	50	149	SPMT060205-PD XOMT060204-PD	FTKA02206S	TW07P
	16525-06	16.5	25	34	83	56	155			
	17025-06	17.0	25	34	88	56	160			
	17525-06	17.5	25	34	88	56	160			
	18025-06	18.0	25	34	93	56	166			
	18525-06	18.5	25	34	93	56	166			
	19025-06	19.0	25	34	98	56	171	SPMT07T208-PD XOMT07T205-PD	FTKA02565	TW07S
	19525-06	19.5	25	34	98	56	171			
	20025-07	20.0	25	34	103	56	178			
	20525-07	20.5	25	34	103	56	178			
	21025-07	21.0	25	34	108	56	183			
	21525-07	21.5	25	34	108	56	183			
	22025-07	22.0	25	34	113	56	188			
	22525-07	22.5	25	34	113	56	188	SPMT090308-PD XOMT090305-PD	FTKA0307	TW09S
	23025-07	23.0	25	34	118	56	195			
	23525-07	23.5	25	34	118	56	195			
	24032-09	24.0	32	44	123	60	205			
	24532-09	24.5	32	44	123	60	205			
	25032-09	25.0	32	44	128	60	210			
	25532-09	25.5	32	44	128	60	210			
	26032-09	26.0	32	44	133	60	215			
	26532-09	26.5	32	44	133	60	215			
	27032-09	27.0	32	44	138	60	221			
	27532-09	27.5	32	44	138	60	221			
28032-09	28.0	32	44	143	60	227				
28532-09	28.5	32	44	143	60	227				
29032-09	29.0	32	44	148	60	232				
29532-09	29.5	32	44	148	60	232				

KING DRILL

KING DRILL-5D

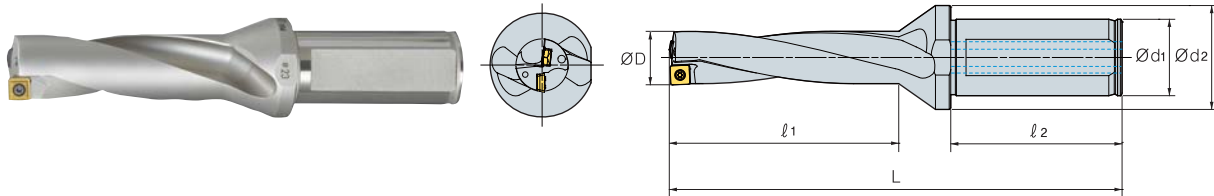



(mm)

Designaton	ØD	Ød1	Ød2	l ₁	l ₂	L	Insert	Screw	Wrech
K5D	30032-11	30.0	32	44	153	60	SPMT11T308-PD XOMT11T306-PD	FTKA03508	TW15S
	30532-11	30.5	32	44	153	60			
	31032-11	31.0	32	44	158	60			
	31532-11	31.5	32	44	158	60			
	32032-11	32.0	32	44	163	60			
	32532-11	32.5	32	44	163	60			
	33032-11	33.0	32	44	168	60			
	33532-11	33.5	32	44	168	60			
	34032-11	34.0	32	44	173	60			
	34532-11	34.5	32	44	173	60			
	35032-11	35.0	32	44	178	60			
	35532-11	35.5	32	44	178	60			
	36040-13	36.0	40	48	184	70			
	36540-13	36.5	40	48	184	70			
37040-13	37.0	40	48	189	70				
37540-13	37.5	40	48	189	70				
38040-13	38.0	40	48	194	70				
38540-13	38.5	40	48	194	70				
39040-13	39.0	40	48	199	70				
39540-13	39.5	40	48	199	70				
40040-13	40.0	40	48	204	70				
40540-13	40.5	40	48	204	70				
41040-13	41.0	40	48	209	70				
41540-13	41.5	40	48	209	70				
42040-13	42.0	40	48	214	70				
42540-13	42.5	40	48	214	70				
43040-15	43.0	40	58	220	70				
43540-15	43.5	40	58	221	70				
44040-15	44.0	40	58	225	70				
44540-15	44.5	40	58	225	70				
45040-15	45.0	40	58	230	70				
45540-15	45.5	40	58	230	70				
46040-15	46.0	40	58	235	70				
46540-15	46.5	40	58	235	70				
47040-15	47.0	40	58	240	70				
47540-15	47.5	40	58	240	70				
							SPMT130410-PD XOMT130406-PD	FTKA0410	TW15S
							SPMT15M510-PD XOMT15M508-PD	FTNC04511	TW20S

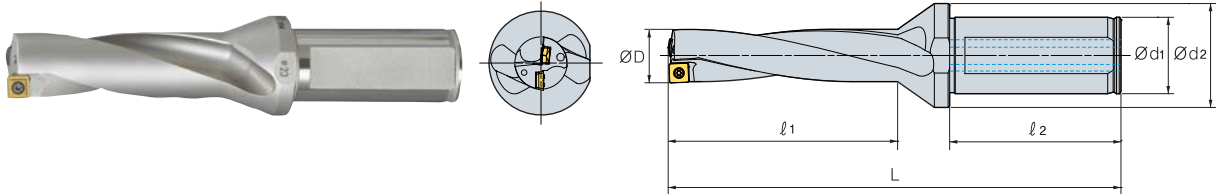
KING DRILL-5D



(mm)

Designaton	ØD	Ød1	Ød2	l1	l2	L	Insert	Screw 	Wrech 
K5D	48040-15	48.0	40	58	245	70	SPMT15M510-PD XOMT15M508-PD	FTNC04511	TW20S
	48540-15	48.5	40	58	245	70			
	49040-15	49.0	40	58	250	70			
	49540-15	49.5	40	58	250	70			
	50040-15	50.0	40	58	255	70			
	50540-15	50.5	40	58	255	70			
51040-18	51.0	40	68	261	70	SPMT180510-PD XOMT180508-PD	FTNA0511	TW20-100	
51540-18	51.5	40	68	261	70				
52040-18	52.0	40	68	266	70				
52540-18	52.5	40	68	266	70				
53040-18	53.0	40	68	271	70				
53540-18	53.5	40	68	271	70				
54040-18	54.0	40	68	276	70				
54540-18	54.5	40	68	276	70				
55040-18	55.0	40	68	281	70				
55540-18	55.5	40	68	281	70				
56040-18	56.0	40	68	286	70				
56540-18	56.5	40	68	286	70				
57040-18	57.0	40	68	292	70				
57540-18	57.5	40	68	292	70				
58040-18	58.0	40	68	298	70				
58540-18	58.5	40	68	298	70				
59040-18	59.0	40	68	304	70				
59540-18	59.5	40	68	304	70				
60040-18	60.0	40	68	310	70				
60540-18	60.5	40	68	310	70				

KING DRILL

KING DRILL (for through coolant system with a lathe)-2D

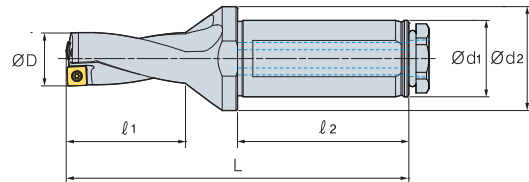
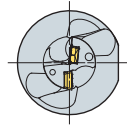

(mm)

Designaton	ØD	Ød1	Ød2	l ₁	l ₂	L	Insert	Screw	Wrech	
K2D	13020HP-04	13.0	20	25	29	50	93	SPMT040204-PD XOMT040204-PD	FTNA0204	TW06P
	14020HP-05	14.0	20	25	31	50	96	SPMT050204-PD XOMT050204-PD	FTNA0204	TW06P
	15020HP-05	15.0	20	25	33	50	99			
	16020HP-05	16.0	20	25	35	50	101			
	17025HP-06	17.0	25	34	37	56	109	SPMT060205-PD XOMT060204-PD	FTKA02206S	TW07P
	18025HP-06	18.0	25	34	39	56	112			
	19025HP-06	19.0	25	34	41	56	114	SPMT07T208-PD XOMT07T205-PD	FTKA02565	TW07S
	20025HP-07	20.0	25	34	43	56	118			
	21025HP-07	21.0	25	34	45	56	120			
	22025HP-07	22.0	25	34	47	56	122			
	23025HP-07	23.0	25	34	49	56	126	SPMT090308-PD XOMT090305-PD	FTKA0307	TW09S
	24032HP-09	24.0	32	44	51	60	133			
	25032HP-09	25.0	32	44	53	60	135			
	26032HP-09	26.0	32	44	55	60	137			
	27032HP-09	27.0	32	44	57	60	140			
	28032HP-09	28.0	32	44	59	60	143			
29032HP-09	29.0	32	44	61	60	145				

KING DRILL (for through coolant system with a lathe)-3D

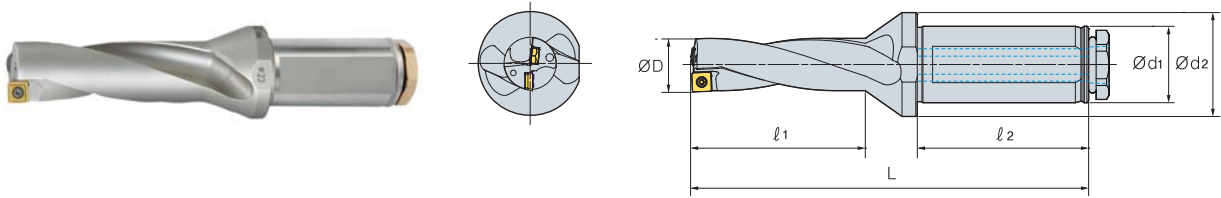

(mm)

Designaton	ØD	Ød1	Ød2	l ₁	l ₂	L	Insert	Screw	Wrech	
K3D	13020HP-04	13.0	20	25	42	50	106	SPMT040204-PD XOMT040204-PD	FTNA0204	TW06P
	13520HP-04	13.5	20	25	42	50	106			
	14020HP-05	14.0	20	25	45	50	110			
	14520HP-05	14.5	20	25	45	50	110			
	15020HP-05	15.0	20	25	48	50	114	SPMT050204-PD XOMT050204-PD	FTNA0204	TW06P
	15520HP-05	15.5	20	25	48	50	114			
	16020HP-05	16.0	20	25	51	50	117			
	16525HP-06	16.5	25	34	51	56	123			
	17025HP-06	17.0	25	34	54	56	126			
	17525HP-06	17.5	25	34	54	56	126			
	18025HP-06	18.0	25	34	57	56	130	SPMT060205-PD XOMT060204-PD	FTKA02206S	TW07P
	18525HP-06	18.5	25	34	57	56	130			
	19025HP-06	19.0	25	34	60	56	133			
	19525HP-06	19.5	25	34	60	56	133			
	20025HP-07	20.0	25	34	63	56	138			
	20525HP-07	20.5	25	34	63	56	138			
	21025HP-07	21.0	25	34	66	56	141			
	21525HP-07	21.5	25	34	66	56	141	SPMT07T208-PD XOMT07T205-PD	FTKA02565	TW07S
	22025HP-07	22.0	25	34	69	56	144			
	22525HP-07	22.5	25	34	69	56	144			
	23025HP-07	23.0	25	34	72	56	149			
	23525HP-07	23.5	25	34	72	56	149			
	24032HP-09	24.0	32	44	75	60	157			
	24532HP-09	24.5	32	44	75	60	157			
	25032HP-09	25.0	32	44	78	60	160			
	25532HP-09	25.5	32	44	78	60	160			
	26032HP-09	26.0	32	44	81	60	163			
	26532HP-09	26.5	32	44	81	60	163	SPMT090308-PD XOMT090305-PD	FTKA0307	TW09S
	27032HP-09	27.0	32	44	84	60	167			
	27532HP-09	27.5	32	44	84	60	167			
	28032HP-09	28.0	32	44	87	60	171			
	28532HP-09	28.5	32	44	87	60	171			
29032HP-09	29.0	32	44	90	60	174				
29532HP-09	29.5	32	44	90	60	174				

KING DRILL

KING DRILL (for through coolant system with a lathe)-4D

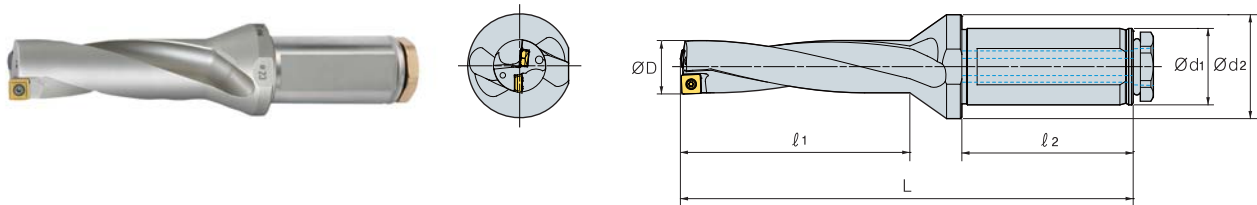

(mm)

Designaton	ØD	Ød1	Ød2	l 1	l 2	L	Insert	Screw	Wrech	
K4D	13020HP-04	13.0	20	25	55	50	119	SPMT040204-PD XOMT040204-PD	FTNA0204	TW06P
	14020HP-05	14.0	20	25	59	50	124	SPMT050204-PD XOMT050204-PD	FTNA0204	TW06P
	15020HP-05	15.0	20	25	63	50	129			
	16020HP-05	16.0	20	25	67	50	133			
	17025HP-06	17.0	25	34	71	56	143	SPMT060205-PD XOMT060204-PD	FTKA02206S	TW07P
	18025HP-06	18.0	25	34	75	56	148			
	19025HP-06	19.0	25	34	79	56	152	SPMT07T208-PD XOMT07T205-PD	FTKA02565	TW07S
	20025HP-07	20.0	25	34	83	56	158			
	21025HP-07	21.0	25	34	87	56	162			
	22025HP-07	22.0	25	34	91	56	166			
	23025HP-07	23.0	25	34	95	56	172			
	24032HP-09	24.0	32	44	99	60	181			
	25032HP-09	25.0	32	44	103	60	185			
	26032HP-09	26.0	32	44	107	60	189			
	27032HP-09	27.0	32	44	111	60	194			
	28032HP-09	28.0	32	44	115	60	199			
29032HP-09	29.0	32	44	119	60	203				

KING DRILL (for large diameter drilling)

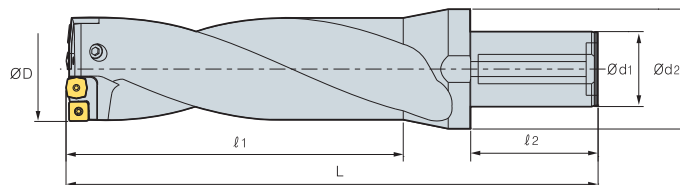

(mm)

Designaton	ØD	Ød1	Ød2	l1	l2	L	Cartridge		Screw	Wrech	
							Insert	Insert			
K2D	616550-11	61~65	50	80	130	85	260	KDC6165C	KDC6165P	FTKA03508	TW15S
	657050-13	65~70	50	88	140	85	270	KDC6570C	KDC6570P	FTKA0410	TW15S
	707550-13	70~75	50	88	150	85	280	KDC7075C	KDC7075P	FTKA0410	TW15S
	758050-13	75~80	50	88	160	85	290	KDC7580C	KDC7580P	FTKA0410	TW15S
	808550-15	80~85	50	88	170	85	300	KDC8085C	KDC8085P	FTNC04511	TW20S
	859050-15	85~90	50	95	180	85	310	KDC8590C	KDC8590P	FTNC04511	TW20S
	909550-15	90~95	50	95	190	85	320	KDC9095C	KDC9095P	FTNC04511	TW20S
	9510050-18	95~100	50	95	200	85	330	KDC95100C	KDC95100P	FTNA0511	TW20-100
K3D	616550-11	61~65	50	80	195	85	325	KDC6165C	KDC6165P	FTKA03508	TW15S
	657050-13	65~70	50	88	210	85	340	KDC6570C	KDC6570P	FTKA0410	TW15S
	707550-13	70~75	50	88	225	85	355	KDC7075C	KDC7075P	FTKA0410	TW15S
	758050-13	75~80	50	88	240	85	370	KDC7580C	KDC7580P	FTKA0410	TW15S
	808550-15	80~85	50	88	255	85	385	KDC8085C	KDC8085P	FTNC04511	TW20S
	859050-15	85~90	50	95	270	85	400	KDC8590C	KDC8590P	FTNC04511	TW20S
	909550-15	90~95	50	95	285	85	415	KDC9095C	KDC9095P	FTNC04511	TW20S
	9510050-18	95~100	50	95	300	85	430	KDC95100C	KDC95100P	FTNA0511	TW20-100
K4D	616550-11	61~65	50	80	260	85	390	KDC6165C	KDC6165P	FTKA03508	TW15S
	657050-13	65~70	50	88	280	85	410	KDC6570C	KDC6570P	FTKA0410	TW15S
	707550-13	70~75	50	88	300	85	430	KDC7075C	KDC7075P	FTKA0410	TW15S
	758050-13	75~80	50	88	320	85	450	KDC7580C	KDC7580P	FTKA0410	TW15S
	808550-15	80~85	50	88	340	85	470	KDC8085C	KDC8085P	FTNC04511	TW20S
	859050-15	85~90	50	95	360	85	490	KDC8590C	KDC8590P	FTNC04511	TW20S
	909550-15	90~95	50	95	380	85	510	KDC9095C	KDC9095P	FTNC04511	TW20S
	9510050-18	95~100	50	95	400	85	530	KDC95100C	KDC95100P	FTNA0511	TW20-100

• Parts

Cartridge		Range (Ø)	Insert				Screw	Wrench
Internal	External		Designation	Quantity	Designation	Quantity		
KDC6165C	KDC6165P	61 ~ 65	XOM(E)T11T306-□□	2	SPM(E)T11T308-□□	2	FTKA03508	TW15S
KDC6570C	KDC6570P	65 ~ 70	XOM(E)T130406-□□	2	SPM(E)T130410-□□	2	FTKA0410	TW15S
KDC7075C	KDC7075P	70 ~ 75	XOM(E)T130406-□□	2	SPM(E)T130410-□□	2	FTKA0410	TW15S
KDC7580C	KDC7580P	75 ~ 80	XOM(E)T130406-□□	2	SPM(E)T130410-□□	2	FTKA0410	TW15S
KDC8085C	KDC8085P	80 ~ 85	XOM(E)T15M508-□□	2	SPM(E)T15M510-□□	2	FTNC04511	TW20S
KDC8590C	KDC8590P	85 ~ 90	XOM(E)T15M508-□□	2	SPM(E)T15M510-□□	2	FTNC04511	TW20S
KDC9095C	KDC9095P	90 ~ 95	XOM(E)T15M508-□□	2	SPM(E)T15M510-□□	2	FTNC04511	TW20S
KDC95100C	KDC95100P	95 ~ 100	XOM(E)T180508-□□	2	SPM(E)T180510-□□	2	FTNA0511	TW20-100



Head Office

Holystar B/D, 1350, Nambusunhwan-ro, Geumcheon-gu, Seoul, 153-823, Korea
Tel : +82-2-522-3181 Fax : +82-2-522-3184, +82-2-3474-4744
Web : www.korloy.com E-mail : export@korloy.com

Cheongju Factory

55, Sandan-ro, Heungdeok-gu, Cheongju-si, Chungcheongbuk-do, 361-290, Korea
Tel : +82-43-262-0141 Fax : +82-43-262-0146

Jincheon Factory

54, Gwanghyewonsandan 2-gil, Gwanghyewon-myeon, Jincheon-gun, Chungcheongbuk-do, 365-831, Korea
Tel : +82-43-535-0141 Fax : +82-43-535-0144

R & D Institute

55, Sandan-ro, Heungdeok-gu, Cheongju-si, Chungcheongbuk-do, 361-290, Korea
Tel : +82-43-262-0141 Fax : +82-43-262-0711



620 Maple Avenue, Torrance, CA 90503, USA
Tel : +1-310-782-3800 Toll Free : +1-888-711-0001 Fax : +1-310-782-3885
www.korloyamerica.com E-mail : sales@korloy.us



Heinrich-Lanz-Allee 12, 60437 Frankfurt am Main, Germany
Tel : +49-69-5069-887-0 Fax : +49-69-5069-887-29
www.korloyeurope.com E-mail : sales@korloyeurope.com



Ground Floor, Property No. 217, Udyog Vihar Phase 4, Gurgaon 122016, Haryana, INDIA
Tel : +91-124-4050030 Fax : +91-124-4050032
www.korloyindia.com E-mail : sales.kip@korloy.com



Av. Aruana 280, conj.12, WLC, Alphaville, Barueri, CEP06460-010, SP, Brasil
Tel : +55-11-4193-3810
E-mail : vendas@korloy.com

www.korloy.com

- Please refer to stock management of cutters and detail dimensions in the 2014~2015 catalogue.

